

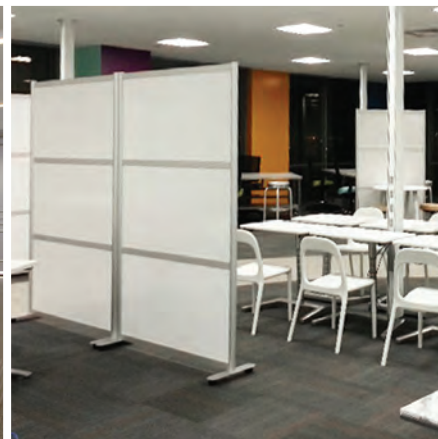

LOFTwall®



MISSION

We are committed to creating innovative & straight forward solutions for environments where you live, work & play.



contents



PRODUCTS

- 5 Wave
- 6 Desk Divider
- 7 4Wall
- 9 6Wall
- 11 8Wall
- 13 Glide
- 15 Sky
- 16 Options

SPACES

- 17 Education
- 19 Healthcare
- 21 Office & Commercial
- 23 Hospitality
- 25 Residential

PRICE GUIDE

- 28 Specification
- 30 4wall, 6wall, 8wall
- 33 Panels
- 34 Add-On Walls
- 37 Products & Options
- 41 How To Order
- 42 Terms & Conditions

LOFTwall Divider Solutions
4705 Vickburg Street
Dallas TX, 75207
Tel: 214.239.3163
Fax: 214.446.6911

www.LOFTwall.com

Inquiries:
info@LOFTwall.com

© 2013 LOFTwall. This publication and content are protected under copyrights of their perspective owners. LOFTwall is a Registered Trademark.

ENVIRONMENTAL IMPACT

OUR COMMITMENT TO SUSTAINABILITY

Making less of an impact and doing good go hand-in-hand with success. In fact, studies show that companies who are both socially and environmentally conscious make more money and have long-term viability.

LOFTwall is committed to being an environmentally and socially conscious company that contributes to a clean and safe environment for its employees and customers. We are forging an integrated path where we embrace the triple bottom line approach to business, delivering value across social, environmental and economic platforms.

At LOFTwall, we have evaluated sources of waste generated and created a procedure for elimination or minimization through recycling, re-engineering, process modification or reduction. Waste not acceptable for recycling is disposed of safely and responsibly within local, state requirements and environmental recommendations.

MATERIALS

At LOFTwall, we evaluate our suppliers' deliverables and processes for adherence to our company's environmental criteria. In striving for sustainability, LOFTwall's cardboard container suppliers have noted that on average, 60% of the goods supplied are manufactured from recycled materials. Our aluminum frames are manufactured from 75% post consumer/post industrial recycled aluminum.

LOFTwall has eliminated harmful Volatile Organic Compounds (VOCs) produced from liquid paints and spray adhesives, through the use of water based/ applied adhesives and powder coating finishes. Powder coating was developed as an environmentally friendly alternative that improves durability. We have taken powder coat to the next level with the inclusion of Dyecoat finish options. This process is the coating and decoration of aluminum and steel with aesthetic or wooden patterns and designs.

In coordination with our vendors, LOFTwall recycles all aluminum, cardboard, and steel accumulated from our internal manufacturing process.

OUR FACILITY

Through the use of a high-efficient HVAC, new lighting, and new plumbing systems, LOFTwall is reducing its energy consumption at its showroom and assembly facility. Through annual internal energy audits, we continue to try to reduce our consumption.

With additional recycling of plastic, cardboard, aluminum, scrap steel and wood pallets, it is clear LOFTwall shares the concern of protecting the environment.



LEED RATING SYSTEM

LOFTwall is a proud member company of the U.S. Green Building Council (USGBC), a national non-profit committed to transforming the built environment. USGBC and its community are changing the way buildings and communities are designed, built and operated.

We believe in better buildings; places that complement our environment and enhance our communities. Places that give people better, brighter, healthier spaces to live, work and play.

Since the USGBC and its certification partner, GBCI, evaluate each project individually, the role our products play in achieving LEED certification will be unique to each project. Depending on which LEED rating system and which credits you pursue, LOFTwall may contribute toward certain LEED points, including Materials & Resources credit 4 - Recycled Content and Indoor Environmental Quality credit 4.5 - Low-Emitting Materials- Furniture & Furnishings. Our LOFTwall frame is 75% recycled aluminum and the panels have low Volatile Organic Compound (VOC) content. For more LEED information, please visit our Website.

PHOTO: Justin Clemons

WAVE



Add an element of motion to your space with Wave. The unique and visually stimulating design adds aesthetic and function to your space. The arrangement of undulating panels provide a visual barrier yet allow air & light to pass through openings. The design functions as a filter, the curved shape of the panels dampen sound and redirect ambient light to pass through the screens openings.

INTERIOR DESIGN
**BEST OF
YEAR HONOREE
2012**

Dimensions

height: 78" / custom
width: 52" / 76" / 100"
depth: panel 9" / feet 13"

Design Features

- Provides visual barrier
- Allows light & sound to transmit
- Aluminum interlocking frame
- Removable panel design
- Custom sizes & options available

Environmental Features

- Frame has 75% recycled content
- Frame is 100% recyclable
- VOC free anodized frame finish

LWW4

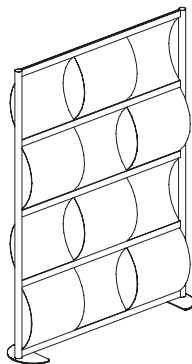

LWW6

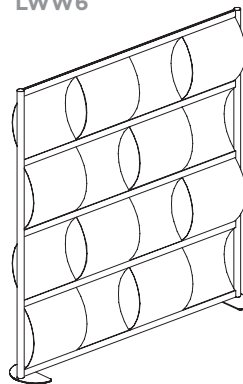

LWW8

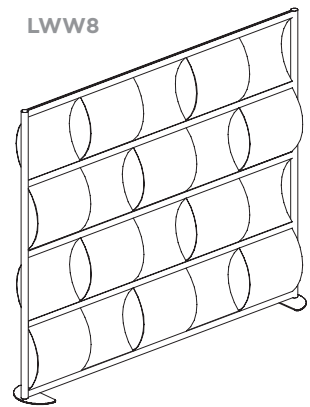



DESK DIVIDER

Desk Divider is a modular table top privacy screen. The modular design provides a privacy screen above the desk and an optional modesty panel below the desk. Available in the full range of panel finishes. Enhance productivity with magnetic, tackable or dry erase surfaces. Mounts to the underside surface.

Dimensions

Height: 18" Privacy / 35" Privacy & Modesty
 Width: 47" / 71" / Custom
 Depth: wall 0.75" / bracket 2.5"

Design Features

- Tabletop or underside mounting bracket
- Privacy and/or modesty panel design
- Aluminum interlocking modular frame
- Translucent and opaque panel options
- Removable panel design
- Frame available in over 40 powder coat finishes
- Custom sizes & options available

Environmental Features

- Frame made from 75% recycled content
- Frame is 100% recyclable
- Panel options meet indoor air quality standards
- VOC free anodized frame finish

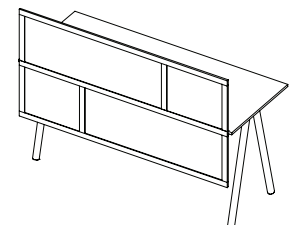
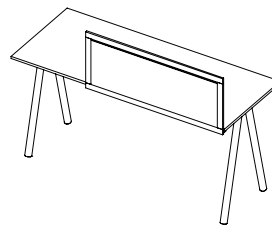

LWDD41

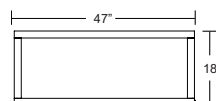

LWDD61

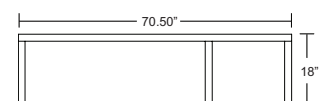

LWDD42

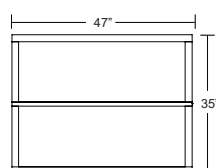

LWDD62

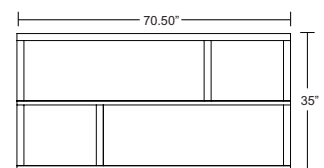

Pricing Information on Page 36



4 WALL

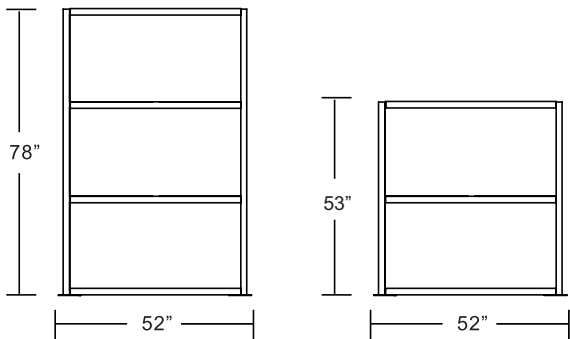

Dimensions

Height: 78" / 53"
 Width: 52" base to base
 Depth: wall 1.75" / base 13"

Design Features

- Freestanding movable wall design
- Aluminum interlocking modular frame
- Translucent and opaque panel options
- Connect multiple walls with LINK
- Removable panel design
- Integration of third party materials
- Caster base option
- Frame available in over 40 powder coat finishes
- Custom sizes & options available

Environmental Features

- Frame made from 75% recycled content
- Frame is 100% recyclable
- Panel options meet indoor air quality standards
- VOC free anodized frame finish



No job too small for 4wall, ideal for creating privacy in tight spaces.

LW41

78" TALL

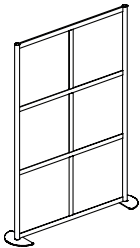

LW42

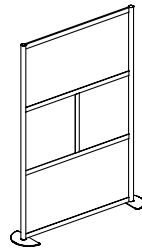

LW44

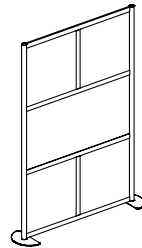

LW45

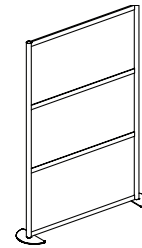

53" TALL

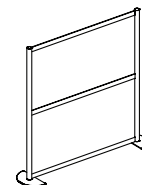
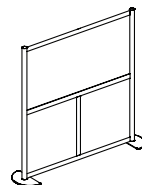
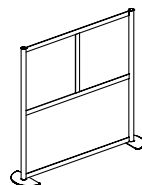
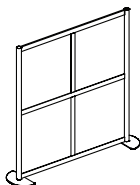

Pricing Information on Page 31



6 WALL

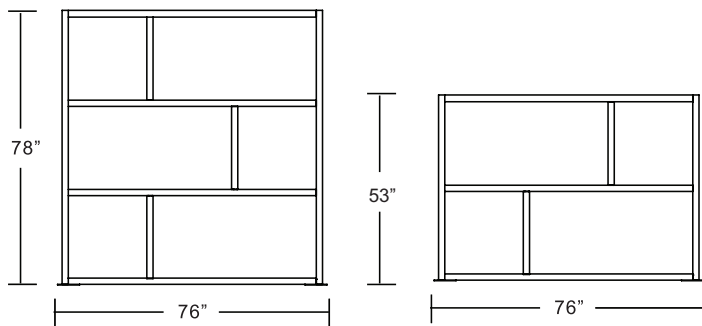

Dimensions

Height: 78" / 53"
Width: 76" base to base
Depth: wall 1.75" / base 13"

Design Features

- Freestanding movable wall design
- Aluminum interlocking modular frame
- Translucent and opaque panel options
- Connect multiple walls with LINK
- Removable panel design
- Integration of third party materials
- Caster base option
- Frame available in over 40 powder coat finishes
- Custom sizes & options available

Environmental Features

- Frame made from 75% recycled content
- Frame is 100% recyclable
- Panel options meet indoor air quality standards
- VOC free anodized frame finish

At home in a lounge or lobby, 6wall is a happy medium of versatility & size.

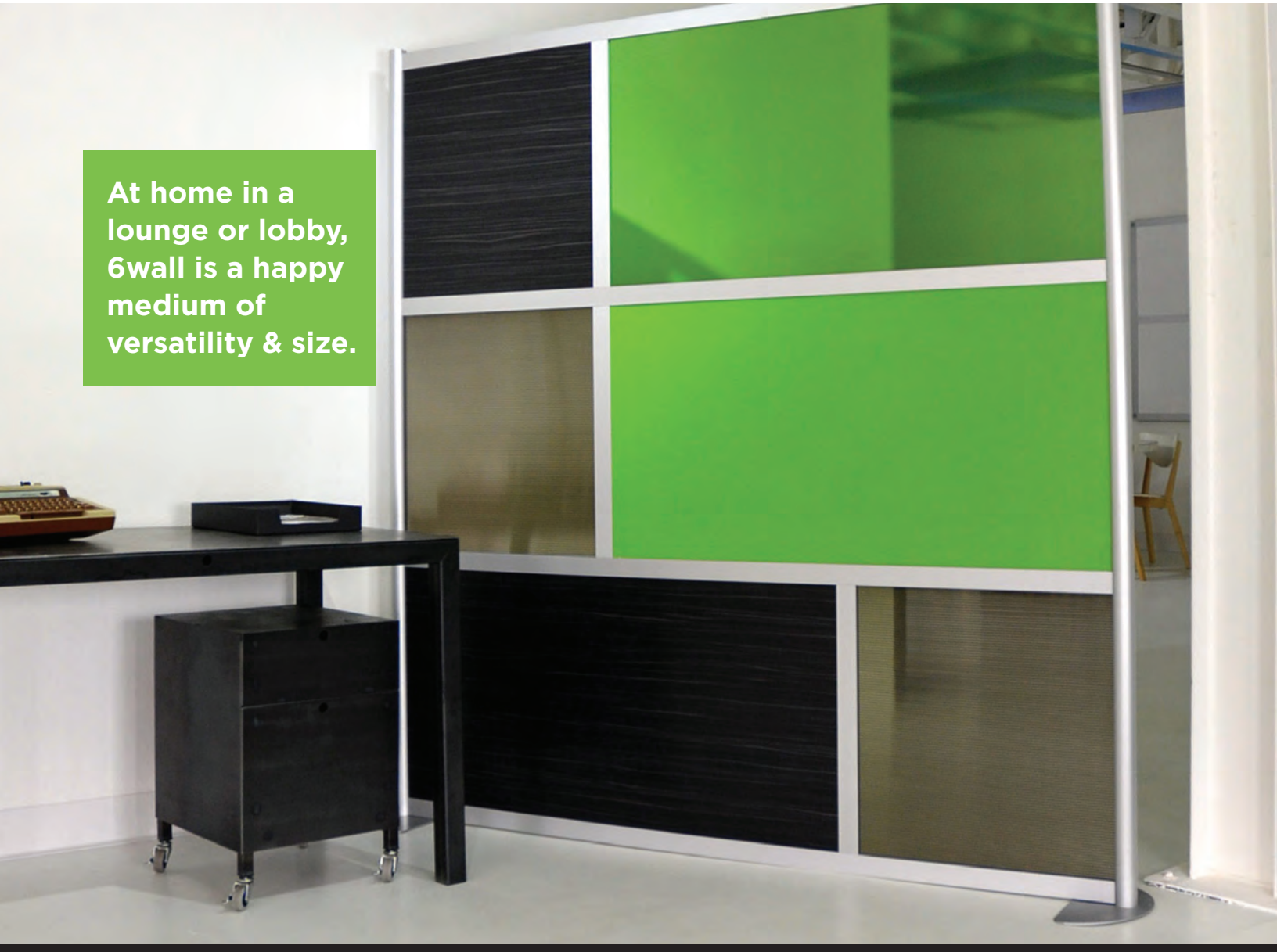

LW61

LW62

LW63

LW64

78" TALL

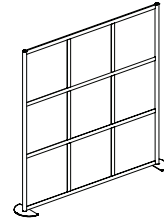
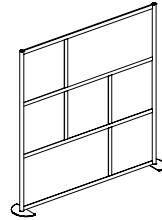
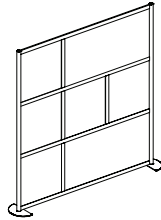
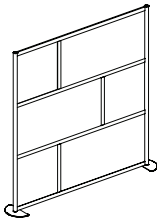

53" TALL

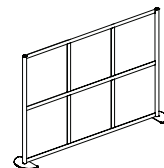
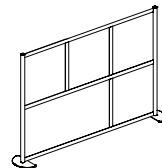
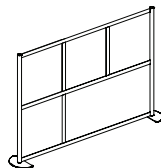
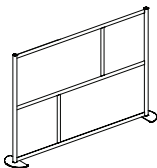

Pricing Information on Page 32



8 WALL

Dimensions

Height: 78" / 53"

Width: 100" base to base

Depth: wall 1.75" / base 13"

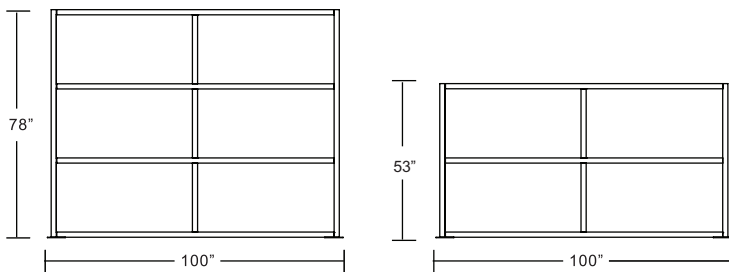

Design Features

- Freestanding movable wall design
- Aluminum interlocking modular frame
- Translucent and opaque panel options
- Connect multiple walls with LINK
- Removable panel design
- Integration of third party materials
- Caster base option
- Frame available in over 40 powder coat finishes
- Custom sizes & options available

Environmental Features

- Frame made from 75% recycled content
- Frame is 100% recyclable
- Panel options meet indoor air quality standards
- VOC free anodized frame finish



Step up to 8wall.
When bigger
spaces demand,
8wall can cover
the spans.

LW81

78" TALL

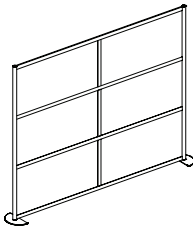

LW82

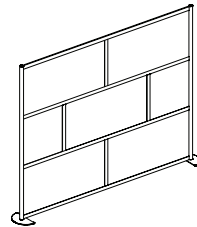

LW83

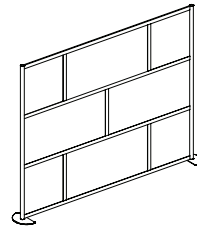

LW84

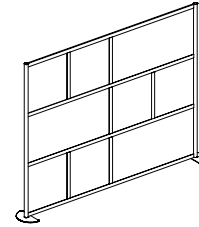

53" TALL

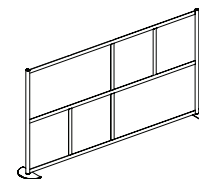
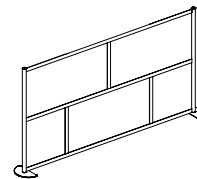
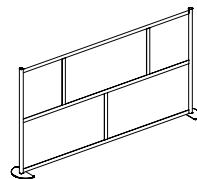
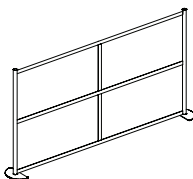

Pricing Information on Page 33

GLIDE



Always on track and easily slides to divide any space.

GLIDE is an overhead sliding partition system. Panels are available in widths 18" to 98" wide. Single or Double track available in 10' sections.

Dimensions

Height: 78"/103"/128"/ custom
Width: 50" / 76" / 98"/ custom
Depth: wall .75" / track 1.10"/2.20"

Design Features

- Overhead track
- Floor guide available
- Modular design
- Multiple track options
- Custom sizes available

Mounted track load is 150lbs per panel/track unit.
Confirm structural integrity before mounting overhead.

GL1 SINGLE TRACK

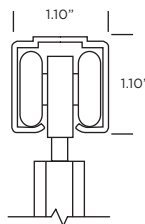

GL2 DOUBLE TRACK

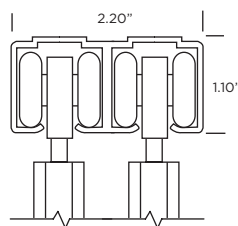

18" - 50" WIDE PANELS

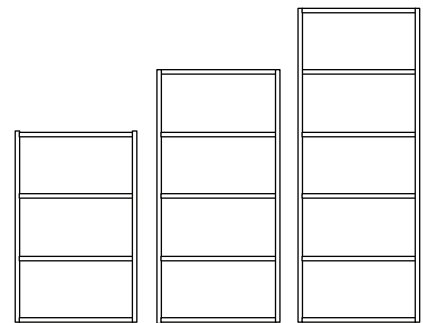

GL43 78" T

GL44 103" T

GL45 128" T



50" - 76" WIDE PANELS

76" - 98" WIDE PANELS

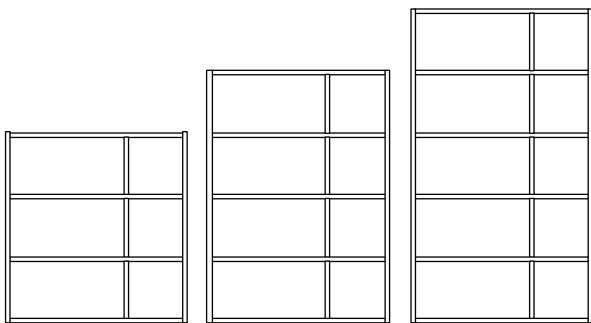

GL63 78" T

GL64 103" T

GL65 128" T

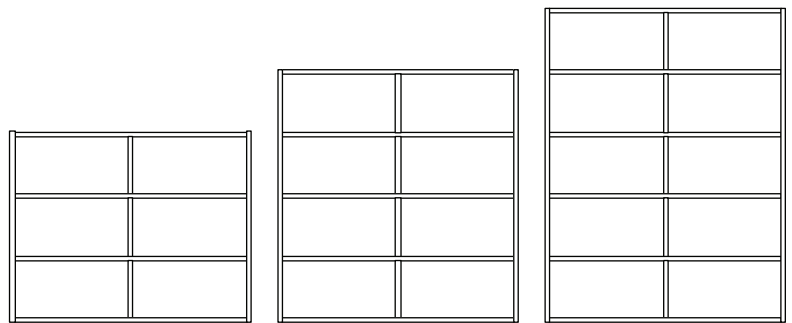

GL83 78" T

GL84 103" T

GL85 128" T

Pricing Information on Page 39



SKY is a suspended element that can be mounted overhead. SKY includes frame and eyebolts for hanging. Custom sizes available. Professional installation may be required.

Dimensions

Height: 78" / Custom
Width: 52" / 76" / 100" / custom
Depth: 1.75"

Design Features

- Overhead suspended elements
- Aluminum interlocking modular frame
- Translucent and opaque panel options
- Custom sizes and configurations
- Changeable panel design

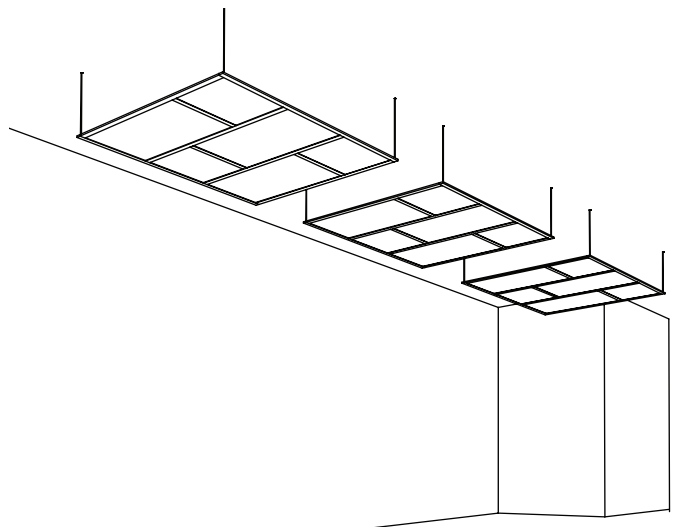

Pricing Information on Page 40

OPTIONS

SHELF

Acrylic shelves screw securely into frame channel.
Available in White, Black or Clear. 10" Depth

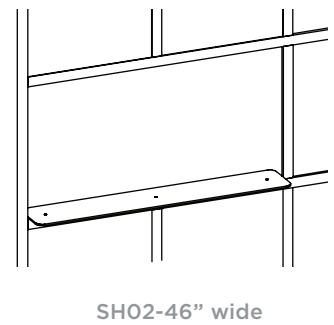
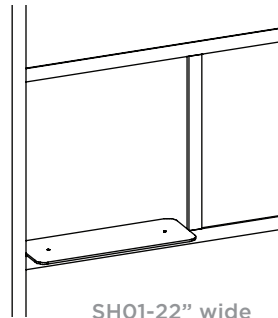

BASES

Base Options for permanent floor, LINK and caster base.

BPO2-Floor Mount Plate

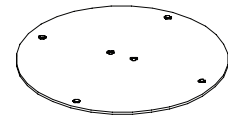

BPO3-Caster Base Set

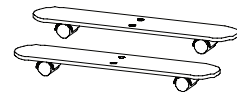

BPO4-12" LINK Base

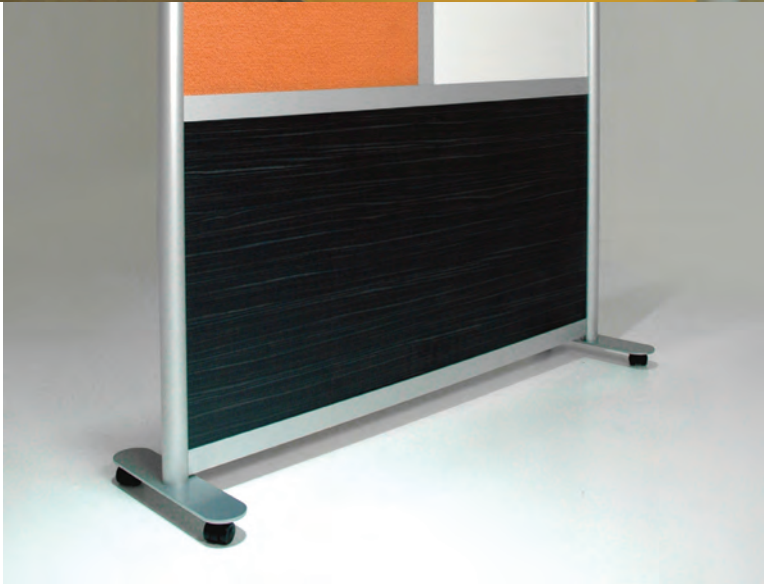

LINK

Connect multiple walls to create unique configurations.
4-way design available in 53" or 78" heights.
Additional base plate available.

LK1-78"

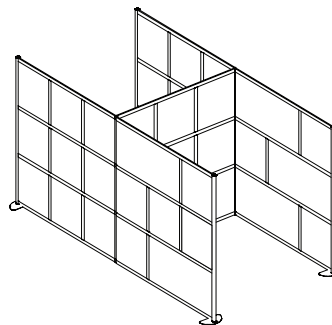

LK2-53"

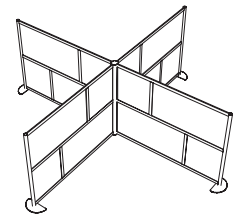

Pricing Information on Page 39

EDUCATION



Today's educational environments require divider solutions that are versatile and easy to maintain. LOFTwall's divider solutions can be customized to facilitate a variety of educational environments. Schools can use LOFTwall to section off classrooms, create teacher work areas, or separate groups of students to create learning areas in libraries.

[Top] 10' wall for entry area with various finishes, customized with graphic branding

[Left] Low height 6' wall with orange & white panels in student lounge

UNIVERSITIES | LIBRARIES | LABS | STUDENT HOUSING



[Above] Custom 6' walls for vending area with floor mount bases, translucent clear, green and wood laminate finishes

Today's educational environments require screening solutions that are versatile and easy to maintain.



[Above] Custom 7' wall for registrar's office



[Left] 6' LOFTwalls in cyber cafe with wood laminate, translucent and custom fabric panels

In a relationship between patient and caregiver, the surroundings can create comfort during the healing process.

[Top Left] 4' low height walls in waiting room with translucent and ebony wood laminate

[Top Right] 16' straight wall in waiting room with frosted acrylic and black solid panels



HEALTHCARE



[Bottom Left] 20' wide custom wall with translucent colored and pearwood laminate panels



WAITING ROOMS | MEDICAL OFFICES | CLINICS



Create privacy and delineate space in a contemporary and practical way for healthcare environments. LOFTwall's partition walls can provide privacy between people and patient in treatment centers and waiting rooms. The panels can be customized with colorful materials that can add comfort and aesthetics. LOFTwall can also have panels made from sound absorbent material, which can reduce noise levels. The panels can be updated with printed information or images to assist patients or staff. The partition wall is flexible when adapting to any medical office or clinic and can be equipped with shelving or castors for multifunctional purposes.

[Above] Multiple walls in waiting area with translucent and pearwood laminate panels

[Left] 6' reception screen in doctor's office, with translucent 3form leaf and ebony wood laminate panels



[Above] 6' low height walls with LINK & custom color frames

OFFICE & COMMERCIAL



Modular divider screens are a flexible solution for office & commercial environments. The moveable freestanding walls offer sleek design and functionality for all kinds of applications. Multiple options for customized panels from wood grain, translucent and solid color. Customize the frame color and enhance panels with branding.



hyper mobile workspaces



Full height & low height 6'
walls with ebony laminate
& clear translucent panels

**As offices evolve into multi-functional open spaces,
having privacy can be a challenge.**



[Above] 4' low height and 8' walls with solid color & clear
translucent panels



[Above] 8' wall with translucent red & frosted acrylic panels

[Opposite Page] 6' wall with custom logo, 8' & 6' low height
walls with custom panels in solid colors, translucent green

HOSPITALITY



[Above] Custom powder coated 6' wall with frosted acrylic and resin panels for dining area



[Left] 6' wall with frosted acrylic and alibaster laminate

RECEPTION | LOUNGES | BUSINESS CENTERS | GYMS



[Above] Custom powder coated 4' wall with frosted acrylic panels for dining area

[Right] 4' Custom powder coated wall with translucent clear and aqua panels

Maintaining intimacy or creating privacy can be a challenge when sharing rooms and facilities with other patrons.





RESIDENTIAL

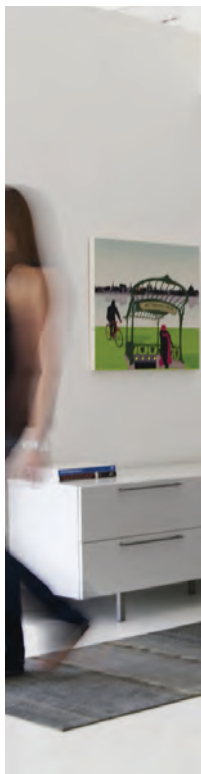

LOFTwall combines the perfect balance of comfort and privacy with an uninhibited vibe of urban, open space living. Designed to create practical function in lofts and studio apartments, LOFTwall divider screens sleekly divide space and can easily be moved or changed as your needs or space changes.

[Above Left] 8' wall with wood laminate asian gray and various translucent panels in white, smoke and clear

[Opposite Page Below Left] 4' wall with wood laminate zebrano finish and resin panels for small home office

[Right] 8' wall with orange fabric, translucent and wood laminate panels

[Below] 6' wall shown with translucent and ebony wood laminate panels



The versatility of LOFTwall allows for distinctive design options while maintaining the open feel of a loft.

PRICE GUIDE

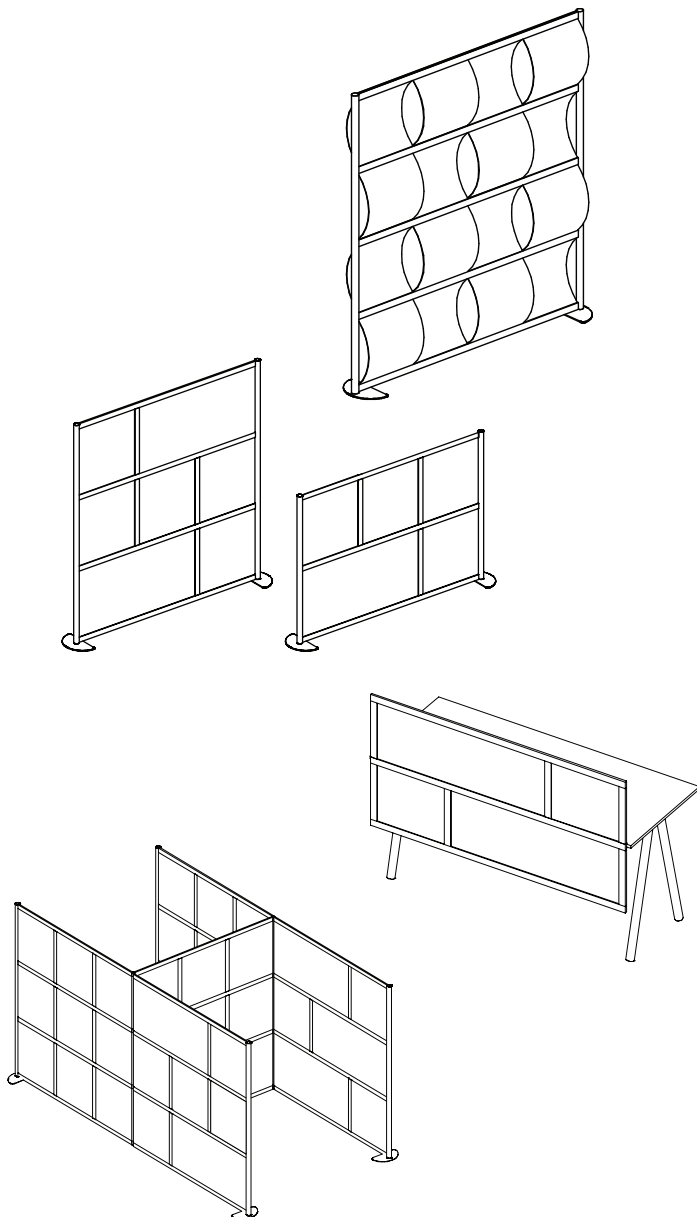

33 SPECIFICATIONS

34 APPLICATION DIAGRAM

35 WALL OPTIONS

- 4wall
- 6wall
- 8wall

38 INFILL PANELS

39 ADD-ON OPTIONS

- 4wall
- 6wall
- 8wall

42 PRODUCTS & OPTIONS

- wave
- desk divider
- glide
- sky
- link
- bases
- shelf
- frame colors

44 HOW TO ORDER

46 TERMS & CONDITIONS

Prices listed as manufacturer's suggested retail price.

SPECIFICATION

Frame is fabricated from interlocking horizontal and vertical members between infill panels. Vertical posts are 1.75" round extruded aluminum profile, horizontal and vertical members are 1.75" tall and .625" deep extruded aluminum profiles. Frame is standard finish in natural aluminum anodize. Bases are cold rolled steel with powdercoat finish.

Configurations 4', 6', 8' widths
78", 53" heights
Custom sizes

Finishes Aluminum - natural anodized
Powdercoated - 40 colors

Bases 1/4" Powdercoated steel

Infill Panels .25" thick panels in various grades of opaque and translucent materials

Linking Multiple walls connect with the use of LINK profiles

INFILL GRADES

Grade A Twinwall Polycarbonate
Solid Color Plastic
Wood Melamine
Dry Erase
Self-Adhesive Tack Board

Grade B Frosted Acrylic
Standard Laminates
Fabric Covered
Custom Cutout

Grade C Customer Supplied Materials
Resin Panel [3Form, Lumicor]
Custom Fabricated panels



LOFTwall is a unique and versatile solution for a variety of applications.

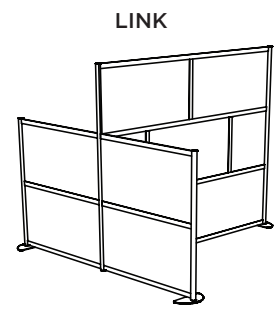
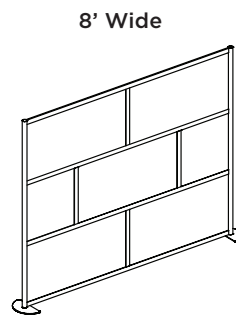
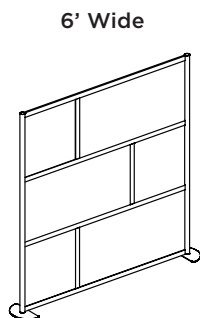
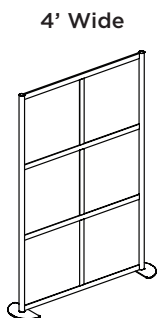
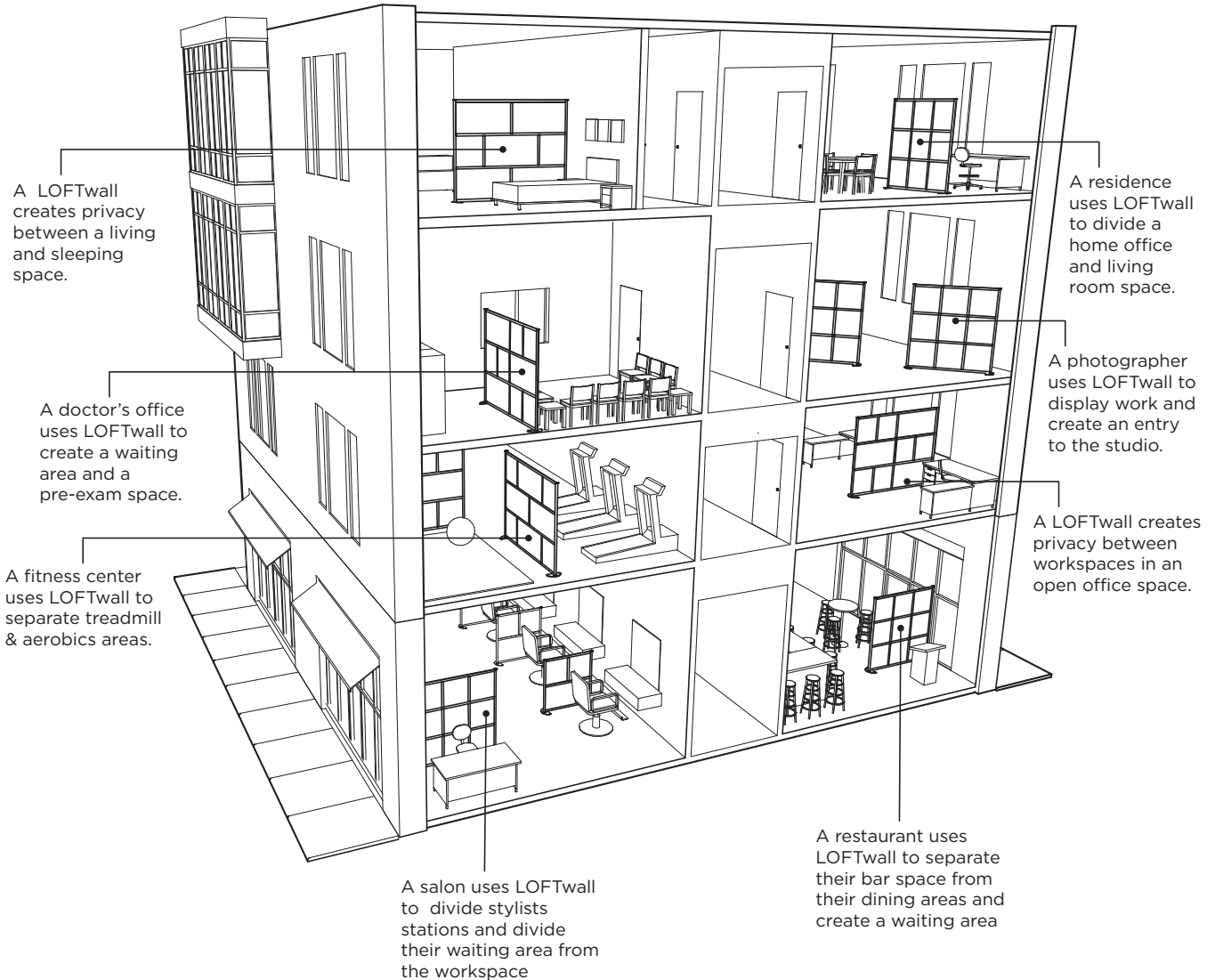

4wall

Frame

Includes hardware, bases & fasteners.

Infills

Grade A - Twinwall Polycarbonate, Solid Color Plastic, Wood Melamine, Dry Erase, Self-Adhesive tack board.

Grade B - Frosted Acrylic, Standard Laminates, Fabric Covered, Custom Cutout, Magnetic Dry Erase

Grade C - Customer Supplied Materials, Wood Veneer, Resin Panel [3Form, Lumicor], Custom Fabricated panels.

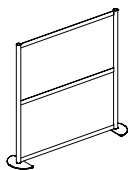
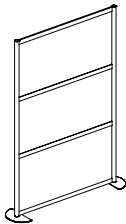
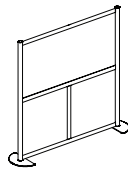
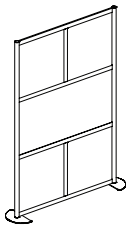
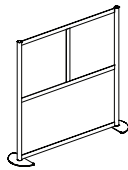
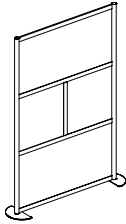
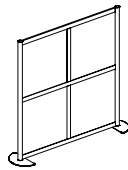
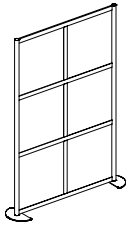
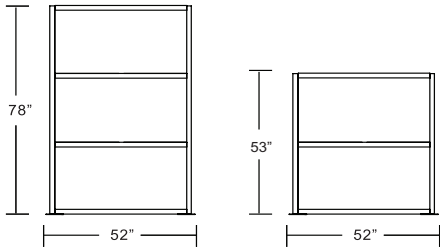

LW41

78" T	Frame Only	A	B	C
	\$1,025	\$1,295	\$1,595	quote
53" T	Frame Only	A	B	C
	\$835	\$1,015	\$1,215	quote

LW42

78" T	Frame Only	A	B	C
	\$950	\$1,145	\$1,520	quote
53" T	Frame Only	A	B	C
	\$750	\$930	\$1,155	quote

LW44

78" T	Frame Only	A	B	C
	\$875	\$1,220	\$1,445	quote
53" T	Frame Only	A	B	C
	\$750	\$930	\$1,130	quote

LW45

78" T	Frame Only	A	B	C
	\$775	\$1,045	\$1,345	quote
53" T	Frame Only	A	B	C
	\$665	\$845	\$1,045	quote

All Prices Listed as MSRP.

6wall

Frame

Includes hardware, bases & fasteners.

Infills

Grade A - Twinwall Polycarbonate, Solid Color Plastic, Wood Melamine, Dry Erase, Self-Adhesive tack board.

Grade B - Frosted Acrylic, Standard Laminates, Fabric Covered, Custom Cutout, Magnetic Dry Erase

Grade C - Customer Supplied Materials, Wood Veneer, Resin Panel [3Form, Lumicor], Custom Fabricated panels.

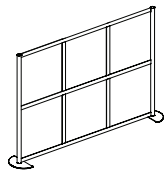
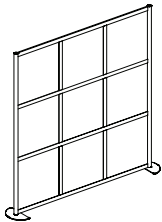
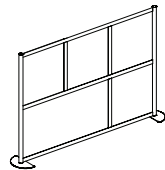
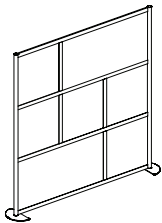
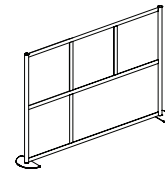
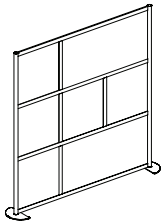
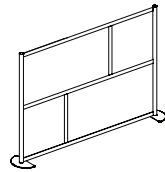
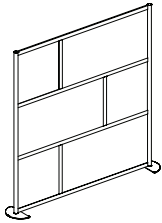
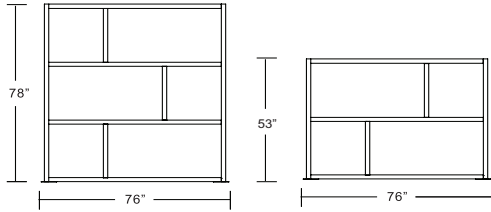

LW61

78" T	Frame Only	A	B	C
	\$1,125	\$1,530	\$1,980	quote
53" T	Frame Only	A	B	C
	\$905	\$1,175	\$1,475	quote

LW62

78" T	Frame Only	A	B	C
	\$1,225	\$1,630	\$2,080	quote
53" T	Frame Only	A	B	C
	\$1,015	\$1,285	\$1,585	quote

LW63

78" T	Frame Only	A	B	C
	\$1,225	\$1,630	\$2,080	quote
53" T	Frame Only	A	B	C
	\$1,015	\$1,285	\$1,585	quote

LW64

78" T	Frame Only	A	B	C
	\$1,375	\$1,780	\$2,230	quote
53" T	Frame Only	A	B	C
	\$1,075	\$1,345	\$1,645	quote

All Prices Listed as MSRP.

8wall

Frame

Includes hardware, bases & fasteners.

Infills

Grade A - Twinwall Polycarbonate, Solid Color Plastic, Wood Melamine, Dry Erase, Self-Adhesive tack board.

Grade B - Frosted Acrylic, Standard Laminates, Fabric Covered, Custom Cutout, Magnetic Dry Erase

Grade C - Customer Supplied Materials, Wood Veneer, Resin Panel [3Form, Lumicor], Custom Fabricated panels.

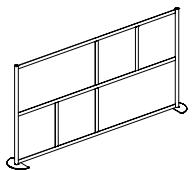
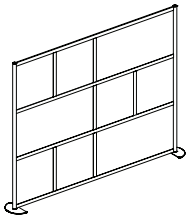
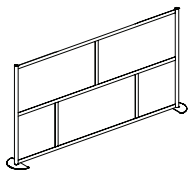
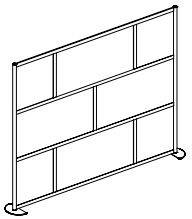
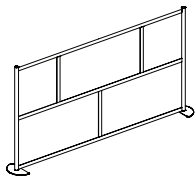
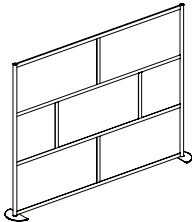
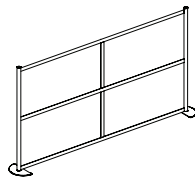
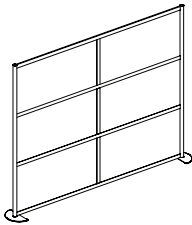
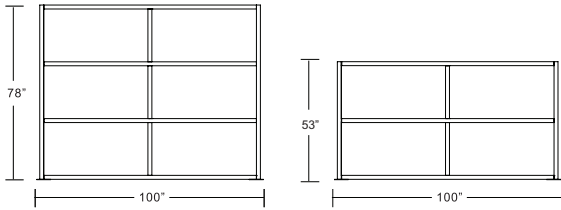

LW81

78" T	Frame Only	A	B	C
	\$1,350	\$1,890	\$2,490	quote
53" T	Frame Only	A	B	C
	\$1,080	\$1,440	\$1,840	quote

LW82

78" T	Frame Only	A	B	C
	\$1,450	\$1,990	\$2,590	quote
53" T	Frame Only	A	B	C
	\$1,175	\$1,535	\$1,935	quote

LW83

78" T	Frame Only	A	B	C
	\$1,535	\$2,075	\$2,675	quote
53" T	Frame Only	A	B	C
	\$1,200	\$1,535	\$1,935	quote

LW84

78" T	Frame Only	A	B	C
	\$1,650	\$2,190	\$2,790	quote
53" T	Frame Only	A	B	C
	\$1,285	\$1,645	\$2,045	quote

All Prices Listed as MSRP.

INFILL PANELS

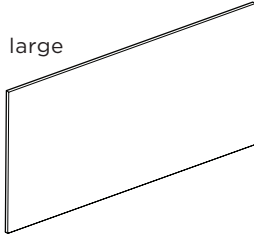
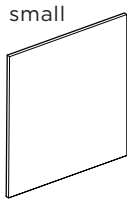

Infills

Infills are available in a range of standard or customer specified finishes. Infill panels are .25" nominal thickness.

GRADE A

- Twinwall Polycarbonate
- Solid Color Plastic
- Wood Melamine
- Dry Erase
- Self-Adhesive Tack Board

GRADE B

- Frosted Acrylic
- Standard Laminates (Wilsonart, Formica, Pionite)
- Fabric Covered
- Custom Cutout
- Magnetic Dry Erase

GRADE C

- Customer Supplied Materials
- Resin Panel [3Form, Lumicor]
- Custom Specialty panels

Grade	Code	Description	Small	Large
A	TW	Twinwall Polycarbonate	\$45	\$90
	SC	Solid Color Plastic		
	WM	Wood Melamine		
	DE	Dry Erase		
	SA	Self-Adhesive Tack Board		
B	FR	Frosted Acrylic	\$95	\$190
	WL	Standard Laminates		
	FB	Fabric Covered		
	CC	Custom Cutout		
	MD	Magnetic Dry Erase		
C	CS	Customer Supplied Materials	quote	quote
	WV	Wood Veneer		
	RP	Resin Panel [3Form, Lumicor]		
	CU	Custom Fabricated panels		

All Prices Listed as MSRP.

4wall Add-On

Frame

Includes hardware, bases & fasteners.

Infills

Grade A - Twinwall Polycarbonate, Solid Color Plastic, Wood Melamine, Dry Erase, Self-Adhesive tack board.

Grade B - Frosted Acrylic, Standard Laminates, Fabric Covered, Custom Cutout, Magnetic Dry Erase

Grade C - Customer Supplied Materials, Wood Veneer, Resin Panel [3Form, Lumicor], Custom Fabricated panels.

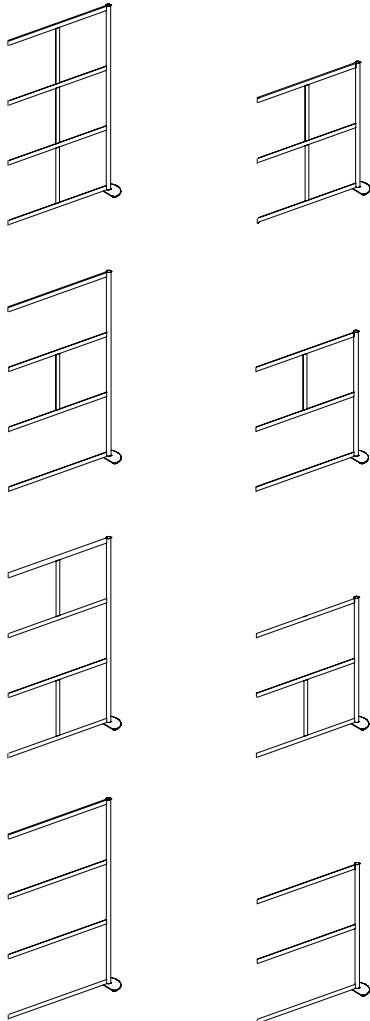
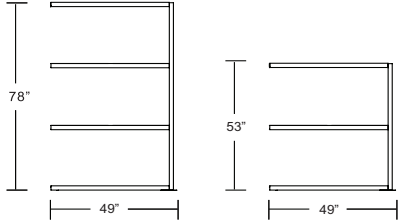

LW41A

78" T	Frame Only	A	B	C
	\$850	\$1,120	\$1,420	quote
53" T	Frame Only	A	B	C
	\$660	\$840	\$1,040	quote

LW42A

78" T	Frame Only	A	B	C
	\$700	\$970	\$1,345	quote
53" T	Frame Only	A	B	C
	\$575	\$755	\$955	quote

LW44A

78" T	Frame Only	A	B	C
	\$775	\$1,045	\$1,270	quote
53" T	Frame Only	A	B	C
	\$575	\$755	\$955	quote

LW45A

78" T	Frame Only	A	B	C
	\$600	\$870	\$1,170	quote
53" T	Frame Only	A	B	C
	\$490	\$670	\$870	quote

All Prices Listed as MSRP.

6wall Add-On

Frame

Includes hardware, bases & fasteners.

Infills

Grade A - Twinwall Polycarbonate, Solid Color Plastic, Wood Melamine, Dry Erase, Self-Adhesive tack board.

Grade B - Frosted Acrylic, Standard Laminates, Fabric Covered, Custom Cutout, Magnetic Dry Erase.

Grade C - Customer Supplied Materials, Wood Veneer, Resin Panel [3Form, Lumicor], Custom Fabricated panels.

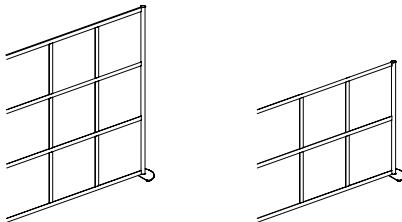
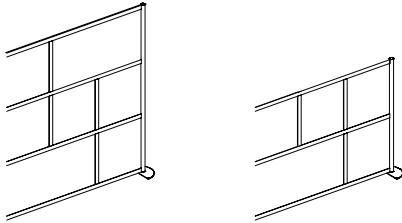
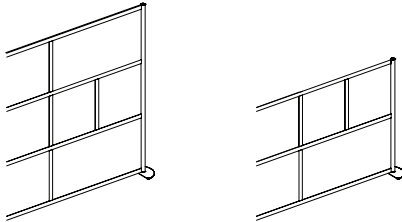
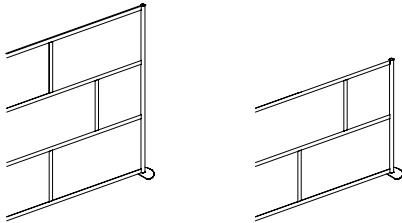
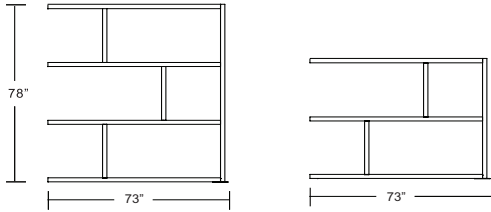

LW61A

78" T	Frame Only	A	B	C
	\$950	\$1,355	\$1,805	quote
53" T	Frame Only	A	B	C
	\$730	\$1,000	\$1,300	quote

LW62A

78" T	Frame Only	A	B	C
	\$1,050	\$1,455	\$1,905	quote
53" T	Frame Only	A	B	C
	\$840	\$1,110	\$1,410	quote

LW63A

78" T	Frame Only	A	B	C
	\$1,050	\$1,455	\$1,905	quote
53" T	Frame Only	A	B	C
	\$840	\$1,110	\$1,410	quote

LW64A

78" T	Frame Only	A	B	C
	\$1,200	\$1,605	\$2,055	quote
53" T	Frame Only	A	B	C
	\$900	\$1,170	\$1,470	quote

All Prices Listed as MSRP.

8wall Add-On

Frame

Includes hardware, bases & fasteners.

Infills

Grade A - Twinwall Polycarbonate, Solid Color Plastic, Wood Melamine, Dry Erase, Self-Adhesive tack board.

Grade B - Frosted Acrylic, Standard Laminates, Fabric Covered, Custom Cutout, Magnetic Dry Erase.

Grade C - Customer Supplied Materials, Wood Veneer, Resin Panel [3Form, Lumicor], Custom Fabricated panels.

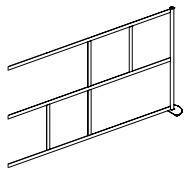
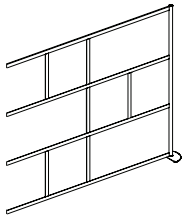
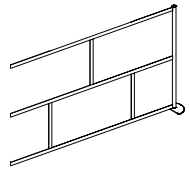
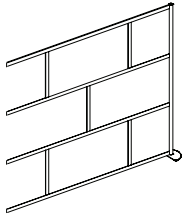
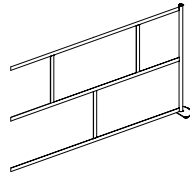
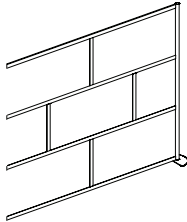
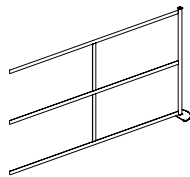
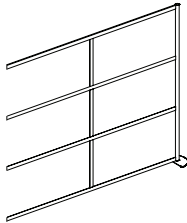
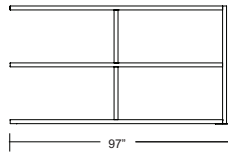
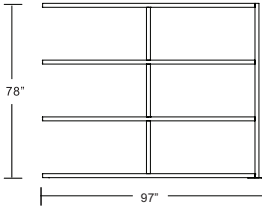

LW81A

78" T	Frame Only	A	B	C
	\$1,175	\$1,715	\$2,315	quote
53" T	Frame Only	A	B	C
	\$905	\$1,265	\$1,665	quote

LW82A

78" T	Frame Only	A	B	C
	\$1,275	\$1,815	\$2,415	quote
53" T	Frame Only	A	B	C
	\$1,000	\$1,360	\$1,760	quote

LW83A

78" T	Frame Only	A	B	C
	\$1,360	\$1,900	\$2,500	quote
53" T	Frame Only	A	B	C
	\$1,025	\$1,360	\$1,760	quote

LW84A

78" T	Frame Only	A	B	C
	\$1,475	\$2,015	\$2,615	quote
53" T	Frame Only	A	B	C
	\$1,110	\$1,470	\$1,870	quote

All Prices Listed as MSRP.

WAVE

Freestanding Wave Screen, 78" Tall
Price includes white, black or orange panels.

		Silver Frame	White Frame
LWW4	52"w	\$1090	\$1290
LWW6	76"w	\$1290	\$1490
LWW8	102"w	\$1490	\$1690

LWW4

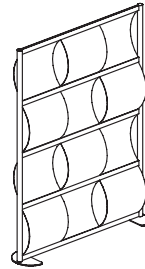

LWW6

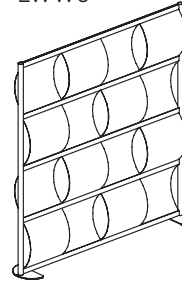

LWW8

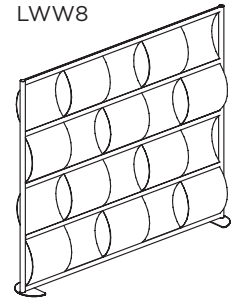

Custom options available.

DESKDIVIDER

Add privacy to any table or desk.
Frame screws into top or bottom of table.
Available in 4' & 6' widths. Custom options available.

Mounting
Bracket

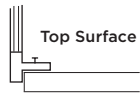

Top Surface

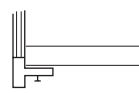

Bottom Surface

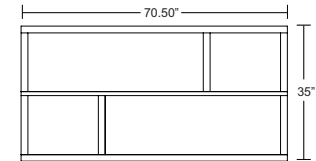
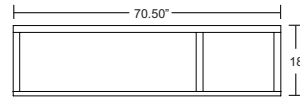
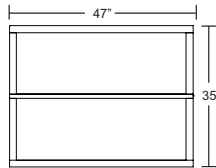
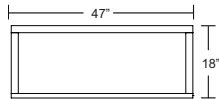
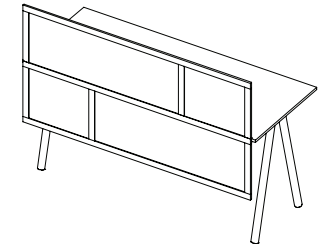
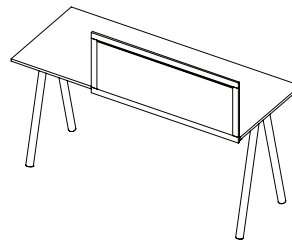

		Frame	Grade A	Grade B
LWDD41	4' Privacy	\$279	\$349	\$449
LWDD42	4' Privacy & Modesty	\$379	\$499	\$599
LWDD61	6' Privacy	\$349	\$399	\$499
LWDD62	6' Privacy & Modesty	\$479	\$549	\$699

MOBI

A mobile personal marker screen 26"W X 78"T

MBD	Dry Erase Panel (A)	\$699
MBM	Magnetic Panel (B)	\$799
MBG	Glass Magnetic Panel	Quote

Price includes similar grade bottom panel option only.

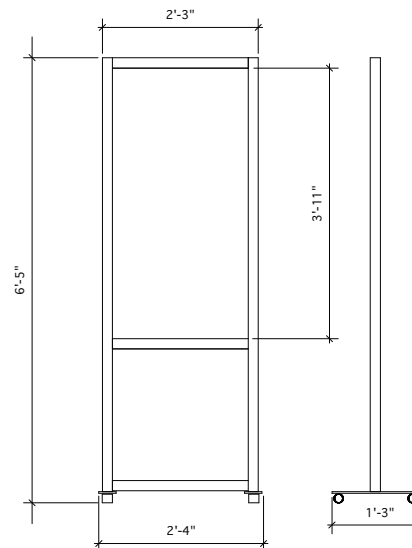

All Prices Listed as MSRP.

GLIDE

Overhead mounted sliding screen system.
 For closets, doorways or open spaces.
 10' track sections in single or double design.
 Optional floor glide brackets available.

How to specify:

- measure height and width of space
- determine open area & number of glide panels
- panel heights & widths can be customized
- allow 2" for track and floor clearance

Mounted track load is 150lbs per panel/track unit.
 Please confirm structural integrity before mounting to overhead support.

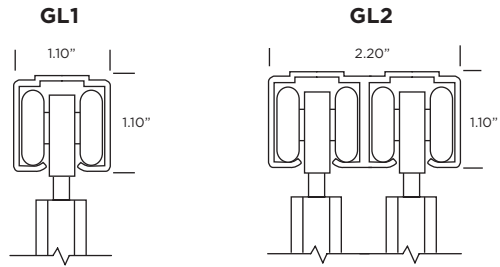

GL1	10' Single Track Section	\$109
GL2	10' Double Track Section	\$139

18"-50" WIDE

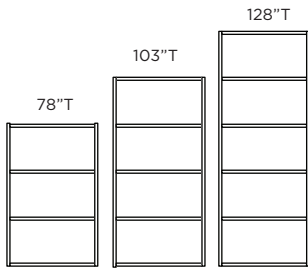

50"-76" WIDE

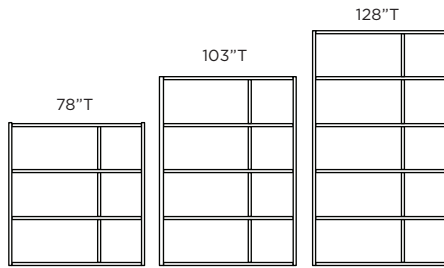

76"-98" WIDE

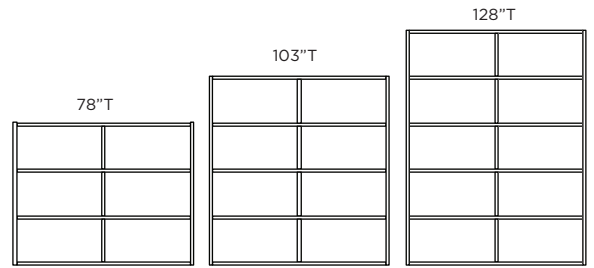

Code	GL43	GL44	GL45	GL63	GL64	GL65	GL83	GL84	GL85
Frame	\$700	\$900	\$1100	\$1100	\$1350	\$1600	\$1300	\$1600	\$1900
Grade A	\$970	\$1260	\$1550	\$1505	\$1890	\$2275	\$1840	\$2320	\$2800
Grade B	\$1270	\$1660	\$2050	\$1955	\$2490	\$2835	\$2440	\$3120	\$3800

Grade C quote

LINK

Connect multiple walls to create unique configurations.
 Additional base plates may be required.

LK1	Full Height LINK - 78"	\$119
LK2	Low Height LINK - 53"	\$99

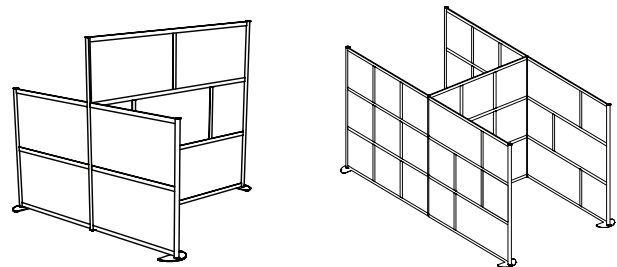

BASES

Base Options for permanent floor, LINK and caster base.

BP02	12" Floor Mount Plate	\$90
BP03	Caster Base Set	\$180
BP04	12" Dia. LINK Base	\$90

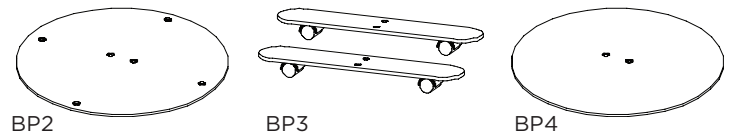

All Prices Listed as MSRP.

SHELF

Acrylic shelves screw securely into frame channel.
Available in White, Black or Clear.

SH01	10"d x 22"w Acrylic Shelf	\$85
------	---------------------------	------

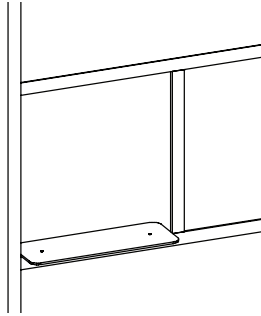

SH02	10"d x 46"w Acrylic Shelf	\$155
------	---------------------------	-------

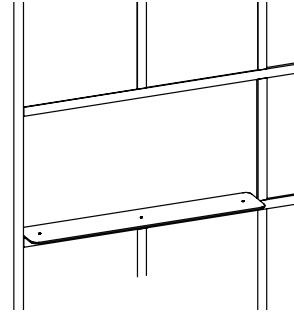

U MOUNT

Attach any frame to permanent wall or surface.
U-Profile pre-drilled for mounting
Professional Installation may be required.

WMU	U Channel Profile 78" Tall	\$199
-----	----------------------------	-------

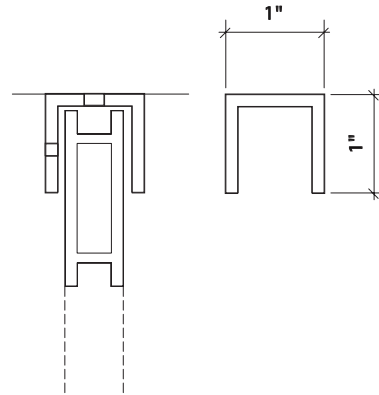

SKY

Convert any frame to enhance overhead spaces.
Eyebolts attached to frame with cables
Professional Installation may be required.

SK1	Conversion Hardware	\$199
-----	---------------------	-------

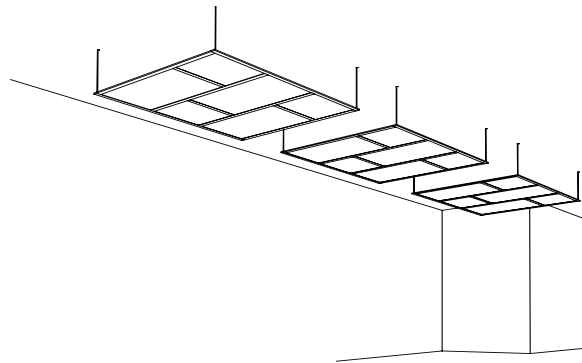

FRAME COLORS

Powdercoating options include standard colors & finishes, custom colors and wood grain finishes. Price includes frame, bases and frame locks.

Finish	Qty 1-3	Qty 4+
36 Standard Colors (See Color Chart)	\$290/per wall	quote
4 Standard Wood Grains (See Color Chart)	\$450/per wall	quote
Custom Match Colors (requires minimum order and mixing charge)	quote	quote

standard panel finishes

SOLID COLORS

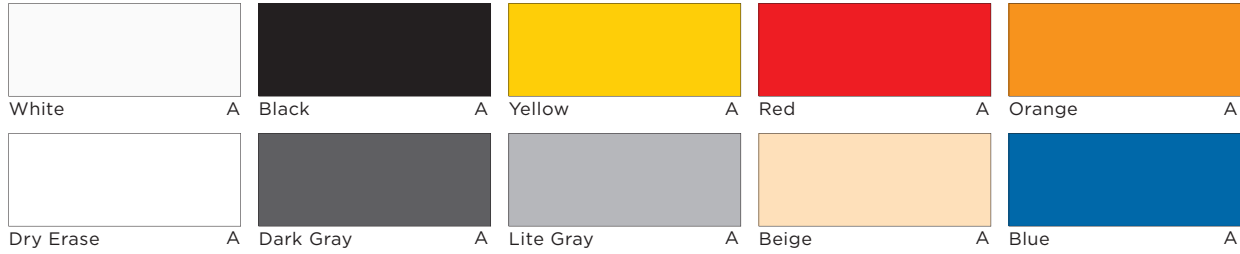

TRANSLUCENT



LAMINATE

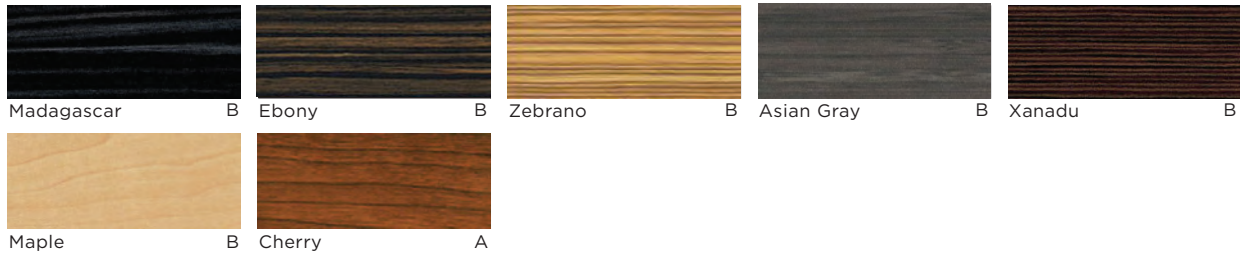

custom frame colors



Swatches colors are printed sample, exact color samples are available upon request

1. Frame Design

Standard Frame	Add-On Frames	Glide Frames	Desk Divider	Wave
LW41	LW41A	GL43	LWDD41	LWW4
LW42	LW42A	GL44	LWDD42	LWW6
LW44	LW44A	GL45	LWDD61	LWW8
LW45	LW45A		LWDD62	
LW61	LW61A	GL63		
LW62	LW62A	GL64	LWDDCS	
LW63	LW63A	GL65		
LW64	LW64A	GL83		
LW81	LW81A	GL84		
LW82	LW82A	GL85		
LW83	LW83A	GLCS		
LW84	LW84A			
LWCS	LWCSA			

2. Height

FH - Full Height LH - Low Height

3. Options

Bases	LINK	GLIDE	SKY	Shelf
BP2	LK1	GL1	SK1	SH1
BP3	LK2	GL2		SH2
BP4				

4. Frame Finish Options

See Custom Powder Coat Finish Chart for Code

5. Panel Materials

Grade A	Grade B	Grade C
TW -Twinwall	FR -Frosted Acrylic	WV - Wood Veneer
SC - Solid Color	FB - Fabric Covered	RP - Resin Panel
DE - Dry Erase	WL - Laminate	PG - Printed Graphic
WM - Melamine	TB - Tack Board	CU - Custom/Specialty
SA - Self-Adhesive	CS - Customer Supplied	

6. Panel Size

22 - Small (approx 2' x 2')
 24 - Large (approx 2' x 4')
 CS - Custom Size

FRAME EXAMPLE



PANEL EXAMPLE



TERMS & CONDITIONS

Eligibility

LOFTwall products are sold in the United States, Canada and Mexico through authorized furniture dealers. Possession of this price list does not constitute authorization to sell and/or purchase products listed herein.

Credit & Payment Terms

Pre-payment is required on the first three(3) orders. Orders over \$5,000 net require a 50% deposit, with the balance due prior to shipping. Credit Terms may be established after completing three orders in an annual period. New account orders in Texas must be accompanied by a State Resale/Exemption Certificate or sales tax will be charged. The credit approval process may take up to twenty business days. Orders will not begin production until credit approval is complete unless prepaid. LOFTwall may review change or cancel credit terms and/or request advance payment at any time.

Terms

Standard terms with open accounts are net 15 from the date of invoice unless otherwise arranged. Orders over \$5,000 net require a 50% deposit, with the balance due net 15. All past due accounts will accrue a 1.5% per month service charge. LOFTwall reserves the right to withhold production or shipment of completed products due to any past due invoices or credit limit.

Prices

All prices listed are effective on the date printed and supersede all previous contract price lists and/or brochures. Prices do not include storage, installation or freight. See freight policy for details. Product specifications and pricing can change at any time without prior notice. Minimum invoice amount is \$50 net.

Custom Products

LOFTwall has made every effort to offer a range of standard configurations. We welcome the opportunity to provide a custom quote based on your design or project. Please contact us for details. LOFTwall cannot be responsible for space layout/design of products. We can provide recommendations based on your input. Custom products cannot be cancelled or returned. Custom products may require a deposit before production.

Storage

Items held in warehouse for more than 30 days after scheduled ship date are invoiced and storage charges may be assessed. Storage fees are 20% per month based on the net total.

Purchase Orders

Orders may be placed by Fax: to (214) 446-6911 or Email: info@loftwall.com. Orders must be confirmed in writing with a signature of authorized buyer before production.

Minimum order charge of \$50 net for orders totaling under \$100 net.

Order Acknowledgement

All orders are acknowledged as LOFTwall interprets them. Acknowledgements are sent via email. It is the customer's responsibility to note any discrepancies on the acknowledgement and notify LOFTwall within 48 hours. If LOFTwall does not receive a signed approval sheet or notification any changes within 48 hours, we will assume the order is correct and are not responsible for changes or errors. Any order that is time sensitive or requires any special instructions, please note instructions and/or requirements on purchase order and we will make every attempt to accommodate your request. LOFTwall is not responsible for any labor charges or installation fees if the shipping date does not meet your requirements.

Order Changes

All requests for changes to an order must be submitted in writing. We will make every attempt to accommodate your changes. Any change to an order may be subjected to a revised scheduled ship date and/or additional charges for materials and labor or rework.

Cancellations/Returns

All requests for cancellations or returns must be submitted in writing for approval by LOFTwall. Please include the following information with your request: Copy of your original sales order and reason for requested cancellation or return. Custom fabricated items cannot be returned. A cancellation acknowledgement will be provided after approval stating that the order has been cancelled. All cancelled orders and/or returns are subject to a 50% restocking fee.

Orders Approved For Return

An RMA (Return Materials Authorization) will be sent via fax with details for return. All products must be packed as they were originally received and returned freight prepaid to our factory unless otherwise noted on RMA. Customer is responsible for any additional damages in transit due to improper packaging. No collect shipments will be accepted for any reason. Please clearly mark all packages with RMA# to expedite RMA process.

Freight

Products may be shipped in compliance with the National Motor Freight Classification Code. Products ship unassembled. Freight is prepaid on a dock to dock basis for all orders. All orders under \$2,500 net are a flat shipping fee of \$85 net per divider product and will be added to the invoice. LOFTwall shall not be held liable for delays caused by strikes, catastrophes, wars, riots, or another cause beyond our control.

Additional Freight Charges

All products are shipped FOB our factory based on a dock delivery only. Additional expenses will be debited from customer account and billed on a separate invoice as "shipping/handling." Examples of additional expenses are: inside delivery, residential delivery and lift gate requirements all have variable charges.

Delivery Inspection

Failure to inspect product at time or receipt, note damages on delivery receipt and/or notify LOFTwall of damages within 7 days of the original date of receipt constitutes acceptance of products and a waiver of all claims. Neither LOFTwall nor the carrier will be responsible for concealed damage claims if shipments are left unopened. Concealed damage must be reported within 7 days from delivery to be valid. Any concealed damage reported after 7 days will not be accepted by LOFTwall and is the responsibility of the customer.

Damaged Freight

All products are loaded on carrier trucks free from defects and/or damage. Responsibility of safe delivery and transport is assumed by the carrier upon loading. It is the customer's responsibility that all cartons, crates, and packages be opened and inspected at time of delivery for damages or shortages regardless of condition. Any damages found during inspection must be clearly noted on the delivery receipt. The carriers should be notified and all packages left in original condition as received for inspection from carrier. LOFTwall factory should be notified immediately. All freight claims are to be processed with the carrier.

Warranty

A Limited Lifetime Warranty applies to products manufactured after June 1, 2009. Warranty is given to the initial purchaser and is valid for as long as the product is owned by the initial purchaser. The warranty, which runs from the date of manufacture, covers defects in materials and craftsmanship found during normal usage of the product during the initial warranty period. If a product is defective, and if written notice of the defect is provided to manufacturer within the Warranty Period, LOFTwall at its option will either repair or replace the defective product with a comparable component or product. Defective product shall be returned at the discretion of LOFTwall, and all returns must be authorized in writing in advance including a Return Materials Authorization Number. LOFTwall assumes no responsibility for labor charges. Freight charges for defective products and parts will be covered by LOFTwall within the 48 continental United States with the method of shipping at LOFTwall's discretion. The limited LifetimeWarranty applies to all products except as listed below:

This warranty does not apply to damage caused by a carrier's alterations to the product expressly authorized by LOFTwall. It also does not apply to "Customer's Own Material" (i.e. material supplied by the customer that is not a standard LOFTwall product offering) used in the manufacture of LOFTwall products. LOFTwall does not warranty the matching of color, grain or texture except to within commercially acceptable standards. A product will not be considered defective and LOFTwall will not be obligated to replace it, if the product is not installed or used as recommended by LOFTwall.



LOFTwall
4705 Vicksburg Street
Dallas TX, 75207
Tel: 214.239.3163
www.LOFTwall.com

